

DC VOLTAGE UP TO 16KV
CHARGING POWER UP TO 1KJ/S



CCR series are designed to offer optimal performance in a compact design for capacitor chargers. Dry isolated, CCR Power Supply from 700V to 16kV provides high reliability without any special maintenance.

APPLICATIONS

- Pulsed applications
- Capacitors
- Research and Développement
- Test Equipment
- Accelerators
- Flash lamps

MAIN SPECIFICATION

- Output Voltage : Up to 16kV
- Charging power: 150J/s to 1kJ/s
- Polarity: Positive-Negative-Reversible-Floating
- Operation frequency : <10Hz, up to 3kHz
- Reproducibility: <0.1%
- Voltage holding: <0.1% p-p of full voltage
- Remote interface : 0-10V analogue

TECHNICAL SPECIFICATIONS

FORMAT	2U or 3U 19" Rack
EFFICIENCY	> 90% at full load
MAINS INPUT	170 to 255 VAC, 47-63 Hz Single Phases + Earth
INPUT POWER FACTOR	≥ 0.98
INRUSH CURRENT	Limited to operating current at full power
REMOTE CONTROL MODE	External 0 to 10V analog interface
REGULATION MODES	Constant Voltage (CV) and Constant Current (CC) regulations, automatic crossover. Power regulation on demand.
STATIC LOAD REGULATION	±0.05% of full voltage or current, from no load to full load (lower on demand)
STATIC LINE REGULATION	±0.05% of full voltage or current for ±10% mains voltage (lower on demand)
STABILITY (AFTER 1-HOUR WARM-UP)	100 ppm/hour, operating at constant load and temperature
PROTECTIONS	Short circuit, Arc quench, External interlock, Over temperature, Overload, Over voltage, Over current
STORED ENERGY	0.2J/kJ
ACCESSORIES	3m removable coaxial HV cable, interlock terminator, safety key

CONTROL

LOCAL CONTROLS	Mains power switch, safety lock, HV on, HV off, Over current mode, Preset, Limitation of voltage setting
OUTPUT VOLTAGE AND CURRENT SETTING	10 turn potentiometer (0.05% resolution) Continuously adjustable from 0 to 100%
VOLTAGE AND CURRENT DISPLAY	4.5 Digit
STATUS INDICATORS	HV on, HV off, Line, Fault, Interlock, Remote, Over current limitation/protection, Regulation mode
REMOTE CONTROL INTERFACE	Standard: 0-10V Analogue On demand: RS-232, Ethernet, 0-10V Isolated Analogue, 0-10V Analogue with 24V relay, Optical fiber
REMOTE CONTROL SOFTWARE	Labview



OPERATING ENVIRONMENT

AMBIENT TEMPERATURE	From 0 to 50 °C
AMBIENT HUMIDITY	0 to 80% at 25°C, 50% at 40°C (non-condensing)
TEMPERATURE COEFFICIENT	100 ppm/°C
COOLING	Air forced Inlet through front panel (dust filters) Outlet at rear panel

STANDARDS AND REGULATIONS

CE CERTIFIED AND ACCORDING	<p>Low voltage directive: 2014/35/EU</p> <p>EMC directive: 2014/30/EU</p> <p>RoHS directive: 2011/65/EU</p> <p>EN 61000-6-2:2005 + AC (2005)</p> <p>EN 61000-6-4:2007 + A1 (2011)</p> <p>EN 61326-1:2013</p> <p>EN 61000-3-2:2014</p> <p>EN 61000-3-3:2013</p> <p>EN 61010-1:2010</p> <p>EUROLAB EMC decision n°11: issue 1 of 18 of December 2007</p>
----------------------------	--

DOCUMENTATION AND SERVICES

DOCUMENTATIONS	<p>User manual</p> <p>Device test report</p> <p>EU declaration of conformity </p> <p>RoHS2 declaration of conformity </p>
WARRANTY	<p>2 years</p> <p>Extension on demand</p>
ON DEMAND	<p>Factory Acceptance Test (FAT)</p> <p>Detailed design report</p> <p>Custom tests</p> <p>Manufacturing process certification</p> <p>Special engineering</p>

INTERFACES

FRONT PANEL

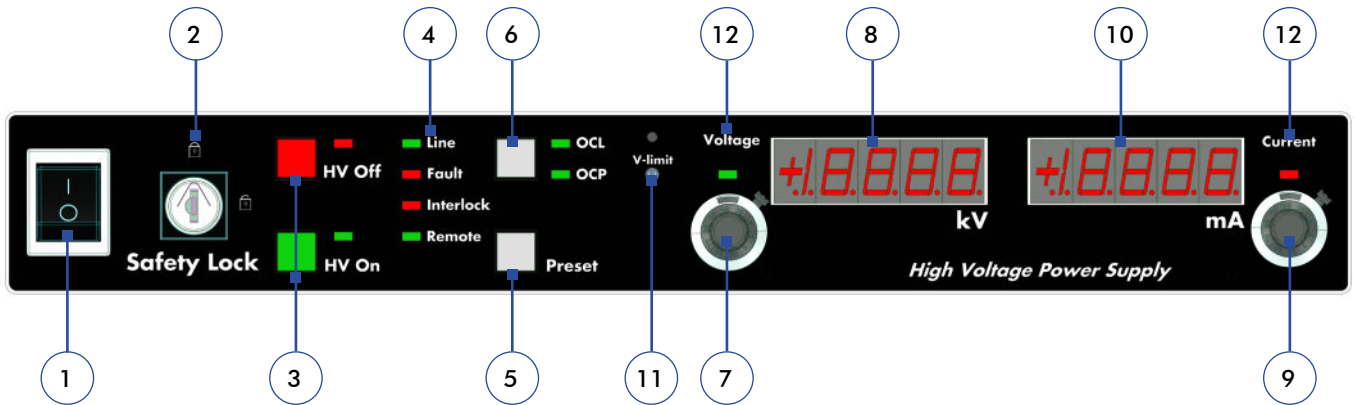

- | | | |
|--|---|---|
| <ul style="list-style-type: none"> 1. ON/OFF switch 2. Safety lock (key) 3. HV ON/OFF push button | <ul style="list-style-type: none"> 4. Statuses (Line, Fault, Interlock, Remote) 5. Preset push button 6. Over Current Limitation (OCL)
Over Current Protection (OCP) 7. Voltage setting 11. Local voltage setting limitation 12.Regulation mode (Voltage) | <ul style="list-style-type: none"> 8. Voltage display 9. Current setting 10. Current display 11. Local voltage setting limitation 12.Regulation mode (Current) |
|--|---|---|

REAR PANEL

- 1. HV output
- 2. RS-232 (option)
- 3. Earth bolt
- 4. Ethernet (option)
- 5. Mains input
- 6. Optical fiber (option)
- 7. Analog interface

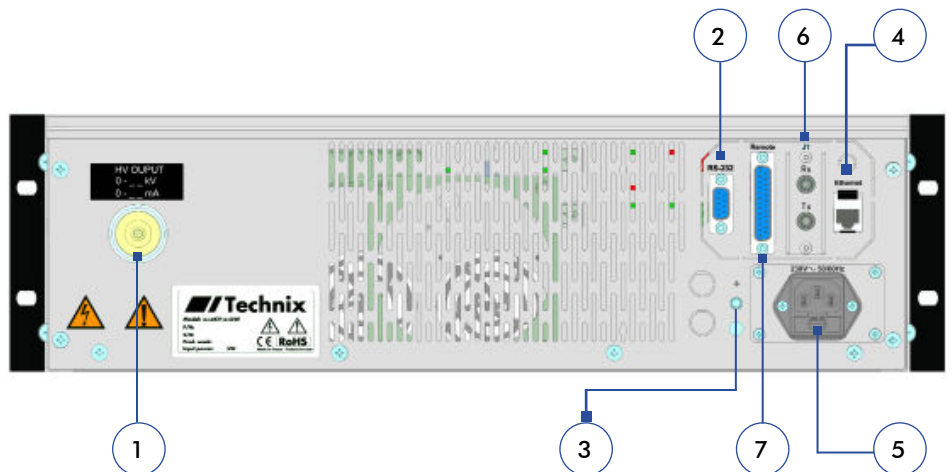

0-10V ANALOG INTERFACE

PIN	SIGNAL	SIGNAL DESCRIPTION	I/O	IMPEDANCE
1	HV-Off control	Produced by a fleeting opening from pin 16	Input	20Ω
2	Fault status	Internal Fault: 0V = Detected; +15V = No fault	Output	100Ω
3	Interlock status	External interlock: 0V = Open; +15V = Closed	Output	475Ω
4	HV-On control	Produced by a fleeting closing to pin 16	Input	20Ω
5	Output voltage measurement	0V to 10V = 0% to 100%	Output	475Ω
6	Output current measurement	0V to 10V = 0% to 100%	Output	475Ω
7	Inhibit control	Activated by digital signal between +5V to +24V	Input	
8	Remote control	Open contact = Local control mode; Closed contact = Remote control mode	Input	20Ω
9	Not connected			
10	Arc monitor (Mains Monitor for older models)	Generates a signal when an arc is detected: +15V = No arc; 0V = Arc detected Older models (shipped before January 2023): Generates a fault if the mains input is failing: 0V = Mains is fine; +15V = Mains is failing	Output	100Ω
11	Output power measurement (option)	0V to 10V = 0% to 100% (option)	Output	475Ω
12	Local output voltage setting	Copy of the setting on the front panel potentiometer. 0V to 10V = 0% to 100%	Output	10Ω
13	Local output current setting	Copy of the setting on the front panel potentiometer. 0V to 10V = 0% to 100%	Output	10Ω
14	Remote output current setting	0V to 10V = 0% to 100%	Input	115Ω
15	+10V reference	+10V reference for analog signals, max current : 5mA	Output	2.7Ω
16	0V reference (digital signals)	0V ground reference for digital signals	Output	
17	Remote output voltage setting	0V to 10V = 0% to 100% of max output voltage	Input	115Ω
18	Regulation mode status or End of Charge status	DC power supply: Open contact = Current Regulation; +24V = Voltage Regulation CC power supply: Open contact = Capacitor charging; +24V = End of charge	Output	100Ω
19	HV-On status	0V = HV output disabled (HV Off) +15V = HV output enabled (HV On)	Output	100Ω
20	0V reference (analogue signals)	0V ground reference for analogue signals	Output	
21-22-23	Not connected			
24	External Interlock	Connect to pin 16 to close the interlock.	Input	500Ω
25	+10V Reference or Remote output power setting (option)	Standard: +10V reference for analog signals, max current : 5mA Option: 0V to 10V = 0% to 100% of max output power	Output	2.7Ω or 115Ω

OPTIONS

- Reversibility
- Floating Outputs
- Auto inhibition
- Parallel operation
- Custom remote interface
- Emergency stop switch
- Special mains input
- Non Instrumented front panel
- Industrial dust filters
- Transportable case
- Remote Front panel
- Tropicalization
- Custom design

RANGES

MODEL REFERENCE: CCR 0.7 kV to 16 kV - 0.15 kJ/s to 1 kJ/s

VOLTAGE

CHARGING POWER

OUTPUT VOLTAGE	150 J/s	300 J/s	600 J/s	1 kJ/s
	Max Current			
0.7 kV	428 mA	857 mA	1.71 A	2.86 A
1 kV	300 mA	600 mA	1.2 A	2 A
2.5 kV	120 mA	240 mA	480 mA	800 mA
5 kV	60 mA	120 mA	240 mA	400 mA
10 kV	30 mA	60 mA	120 mA	100 mA
15 kV	20 mA	40 mA	80 mA	Contact us
16 kV	Contact us			

DIMENSION

MODEL 2U - 19" : 133 x 483 x 480mm (H x W x D)

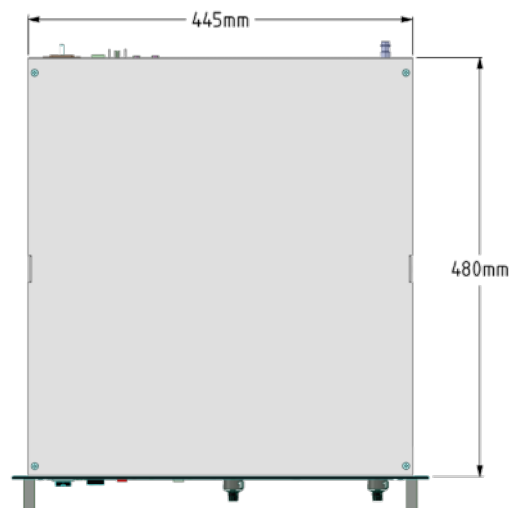
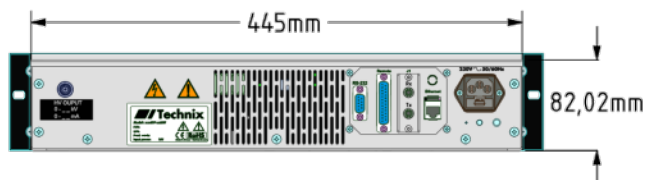
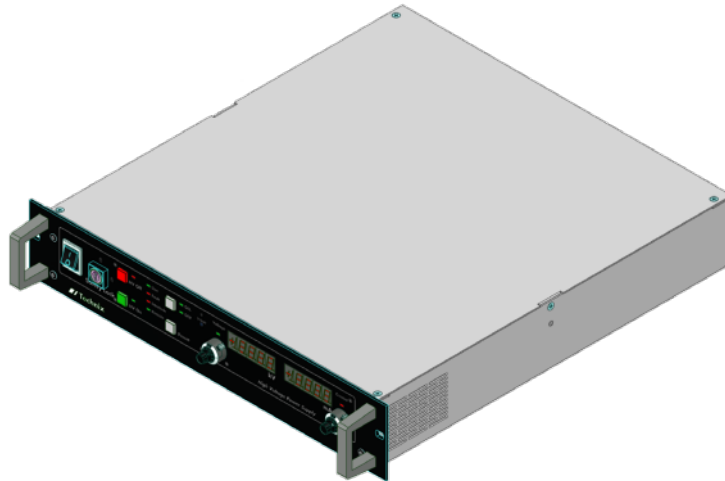

DIMENSION

MODEL 3U - 19" : 133 x 483 x 480mm (H x W x D)

