

VOLTAGE UP TO 60KV

CHARGING POWER UP TO 24KJ/S



CCR serie are capacitor chargers designed to offer optimal performance in a compact design. Air or Oil isolated, they provide high reliability without any special maintenance.

APPLICATIONS

- Pulsed applications
- Capacitor Charging
- Research and Development
- Test Equipment
- Particle Accelerators
- Nuclear Fusion
- Flash lamps
- Marx Generator

MAIN SPECIFICATION

- Output Voltage : Up to 60kV
- Charging power: 750J/s to 40kJ/s
- Polarity: Positive-Negative-Reversible-Floating
- Operation frequency : 10Hz, up to 3kHz
- Reproducibility: 0.1%
- Voltage holding: 0.1% p-p of full voltage
- Remote interface : 0-10V analog

TECHNICAL SPECIFICATIONS

FORMAT	19" Rack or 19" cabinet
EFFICIENCY	> 90% at full load
MAINS INPUT	400 VAC \pm 10%, 47-63 Hz 3 Phases + Earth
INPUT POWER FACTOR	\geq 0.90 at full load
INRUSH CURRENT	Limited to operating current at full power
REGULATION MODES	Charging with constant current switches to voltage regulation once the charging voltage is reached
STATIC LOAD REGULATION	\pm 0.05% of full voltage or current, from no load to full load (lower on demand)
STATIC LINE REGULATION	\pm 0.05% of full voltage or current for \pm 10% mains voltage (lower on demand)
STABILITY (AFTER 1-HOUR WARM-UP)	100 ppm/hour, 300 ppm/ 8 hours of operating at constant load and temperature
PROTECTIONS	Short circuit, Arc quench, External interlock, Over temperature, Overload, Over voltage, Over current
STORED ENERGY	0.2 J/kJ
ACCESSORIES	3m removable coaxial HV cable, interlock terminator, 2 safety keys

CONTROL

LOCAL CONTROLS	Mains power switch, safety lock, HV on, HV off, Preset, Limitation of voltage setting
OUTPUT VOLTAGE AND CURRENT SETTING	10 turn potentiometer (0.05% resolution) Continuously adjustable from 0 to 100%
VOLTAGE AND CURRENT DISPLAY	4.5 Digit
STATUS INDICATORS	HV on, HV off, Line, Fault, Interlock, Remote, Regulation mode (end of charge)
REMOTE CONTROL INTERFACE	0-10V Analog On demand: RS-232, Ethernet, 0-10V Isolated Analog, 0-10V Analog with 24V relay, Optical fiber
REMOTE CONTROL SOFTWARE	On demand Labview



OPERATING ENVIRONMENT

AMBIENT TEMPERATURE	From 0 to 50 °C
AMBIENT HUMIDITY	0 to 80% at 25°C, 50% at 40°C (non-condensing)
TEMPERATURE COEFFICIENT	100 ppm/°C
COOLING	Air forced Inlet through front panel (dust filters) Outlet at rear panel

STANDARDS AND REGULATIONS

CE CERTIFIED	Low voltage directive: 2014/35/EU EMC directive: 2014/30/EU RoHS directive: 2011/65/EU EN 61000-6-2: 2019 EN 61000-6-4: 2019 EN 61326-1: 2021 EN 61000-3-2: 2019 EN 61000-3-3: 2013 + A1: 2019 EN 61010-1: 2010 + A1: 2019 EUROLAB EMC decision n°11: issue 1 of 18 of December 2007
--------------	---

DOCUMENTATION AND SERVICES

DOCUMENTATIONS	User manual Test report EU declaration of conformity  RoHS2 declaration of conformity 
WARRANTY	2 years Extension on demand
ON DEMAND	Witnessed Factory Acceptance Test (FAT) Detailed design report Custom tests Manufacturing process certification Special engineering

INTERFACES

FRONT PANEL

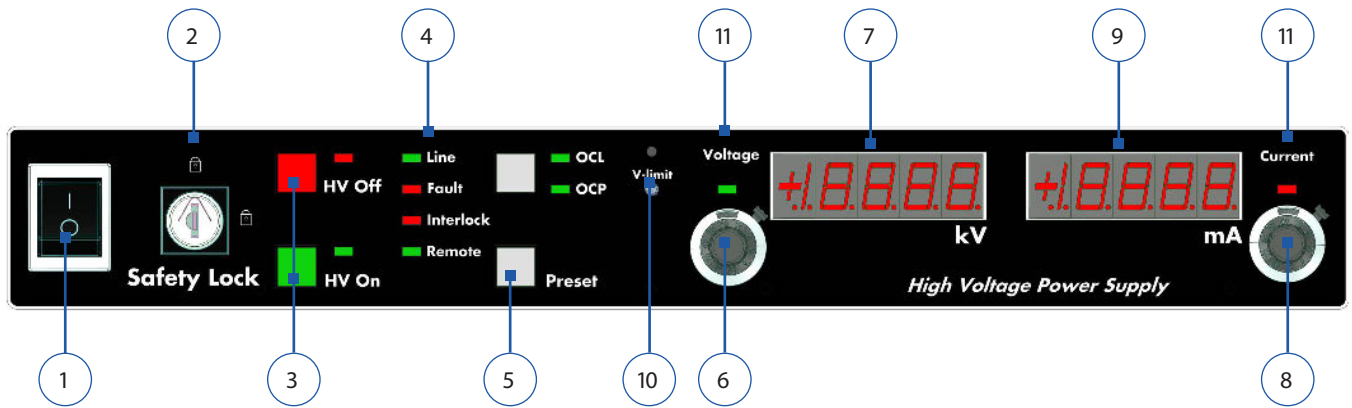

- | | | |
|--------------------------|--|--------------------------------------|
| 1. ON/OFF switch | 4. Statuses (Line, Fault, Interlock, Remote) | 8. Current setting |
| 2. Safety lock (key) | 5. Preset push button | 9. Current display |
| 3. HV ON/OFF push button | 6. Voltage setting | 10. Local voltage setting limitation |
| | 7. Voltage display | 11. Regulation mode |

REAR PANEL

1. HV output
2. Analog interface
3. Mains input
4. Earth bolt
5. RS-232 (option)
6. Optical fiber (option)
7. Ethernet (option)

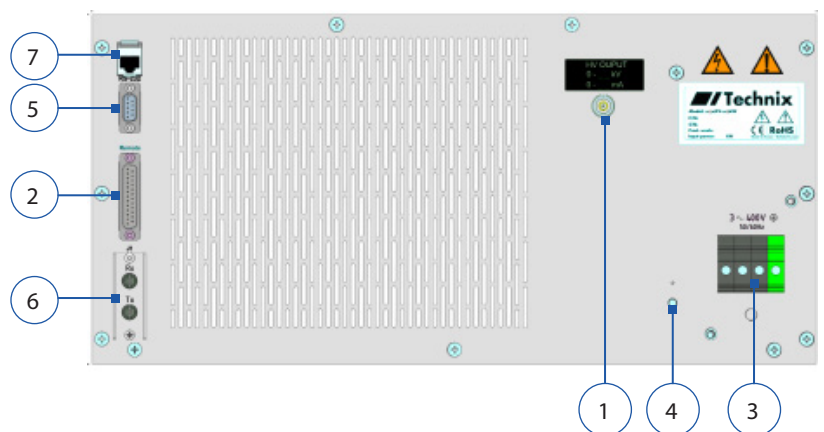
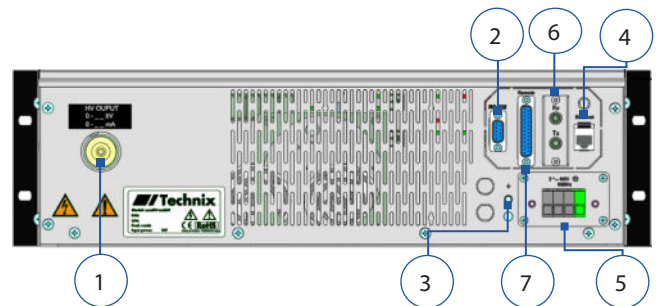

0-10V ANALOG INTERFACE

PIN	SIGNAL	SIGNAL DESCRIPTION	I/O	IMPEDANCE
1	HV-Off control	Produced by a fleeting opening from pin 16	Input	20Ω
2	Fault status	Internal Fault: 0V = Detected; +15V = No fault	Output	100Ω
3	Interlock status	External interlock: 0V = Open; +15V = Closed	Output	475Ω
4	HV-On control	Produced by a fleeting closing to pin 16	Input	20Ω
5	Output voltage measurement	0V to 10V = 0% to 100%	Output	475Ω
6	Output current measurement	0V to 10V = 0% to 100%	Output	475Ω
7	Inhibit control	Activated by digital signal between +5V to +24V	Input	
8	Remote control	Open contact = Local control mode Closed contact = Remote control mode	Input	20Ω
9	Not connected			
10	Arc monitor (Mains Monitor for older models)	Generates a signal when an arc is detected: +15V = No arc; 0V = Arc detected Older models (shipped before January 2023): Generates a fault if the mains input is failing: 0V = Mains is fine ; +15V = Mains is failing	Output	100Ω
11	Output power measurement (option)	0V to 10V = 0% to 100% (option)	Output	475Ω
12	Local output voltage setting	Copy of the setting on the front panel potentiometer. 0V to 10V = 0% to 100%	Output	10Ω
13	Local output current setting	Copy of the setting on the front panel potentiometer. 0V to 10V = 0% to 100%	Output	10Ω
14	Remote output current setting	0V to 10V = 0% to 100%	Input	115Ω
15	+10V reference	+10V reference for analog signals, max current : 5mA	Output	2.7Ω
16	0V reference (digital signals)	0V ground reference for digital signals	Output	
17	Remote output voltage setting	0V to 10V = 0% to 100% of max output voltage	Input	115Ω
18	Regulation mode status or End of Charge status	DC power supply: Open contact = Current Regulation; +24V = Voltage Regulation CC power supply: Open contact = Capacitor charging; +24V = End of charge	Output	100Ω
19	HV-On status	0V = HV output disabled (HV Off) +15V = HV output enabled (HV On)	Output	100Ω
20	0V reference (analog signals)	0V ground reference for analog signals	Output	
21-22-23	Not connected			
24	External Interlock	Connect to pin 16 to close the interlock.	Input	500Ω
25	+10V Reference or Remote output power setting (option)	Standard: +10V reference for analog signals, max current : 5mA Option: 0V to 10V = 0% to 100% of max output power	Output	2.7Ω or 115Ω

OPTIONS

- Reversibility
- Floating Outputs
- Auto inhibition after discharge
- Parallel operation
- Custom remote interface
- Emergency stop switch
- Special mains input
- Non Instrumented front panel
- Industrial dust filters
- Transportable case
- Remote Front panel
- Tropicalization
- Custom design

RANGE

MODEL REFERENCE: CCR 1 kV to 60 kV - 750 J to 24 kJ

VOLTAGE

CHARGING POWER

CHARGING POWER	750 J/s	1.5 kJ/s	2.5 kJ/s	3 kJ/s	4 kJ/s	5 kJ/s	6 kJ/s	7.5 kJ/s	8 kJ/s	10 kJ/s	12 kJ/s	15 kJ/s	20 kJ/s	24 kJ/s
OUTPUT VOLTAGE	Max Current													
1 kV	1.50 A	3 A	5 A	6 A	8 A	10 A	12 A	14 A	16 A	20 A	24 A	30 A	40 A	48 A
2.5 kV	600 mA	1.20 A	2 A	2.40 A	3.20 A	4 A	4.80 A	5.6 A	6.40 A	8 A	9.60 A	12 A	16 A	19.2 A
5 kV	300 mA	600 mA	1 A	1.2 A	1.60 A	2 A	2.40 A	2.8 A	3.20 A	4 A	4.80 A	6 A	8 A	9.60 A
10kV	150 mA	300 mA	500 mA	600 mA	800 mA	1 A	1.20A	1.4 A	1.60 A	2 A	2.40 A	3 A	4 A	4.80 A
15 kV	100 mA	200 mA	330 mA	400 mA	530 mA	670 mA	800 mA	933 mA	1.06 A	1.33 A	1.60 A	2 A	2.67 A	3.20 A
20 kV	75 mA	150 mA	250 mA	300 mA	400 mA	500 mA	600 mA	700 mA	800mA	1 A	1.20 A	1.50 A	2 A	2.40 A
25 kV	60 mA	120 mA	200 mA	240 mA	320 mA	400 mA	480 mA	560 mA	640 mA	800 mA	960 mA	1.20 A	1.60 A	1.92 A
30 kV	50 mA	100 mA	167 mA	200 mA	270 mA	330 mA	400 mA	467 mA	533 mA	667 mA	800 mA	1 A	1.33 A	1.60 A
40 kV	37.5 mA	75 mA	125 mA	150 mA	200 mA	250 mA	300 mA	350 mA	400 mA	500 mA	600 mA	750 mA	1 A	1.20 A
50 kV	30 mA	60 mA	100 mA	120 mA	160 mA	200 mA	240 mA	280 mA	320 mA	400 mA	480 mA	600 mA	800 mA	960 mA
60 kV	25 mA	50 mA	83 mA	100 mA	130 mA	170 mA	200 mA	233 mA	266 mA	330 mA	400 mA	500 mA	667 mA	800 mA

DIMENSION

MODEL 3U - 19" : 133 x 483 x 480 or 600 mm (H x W x D)

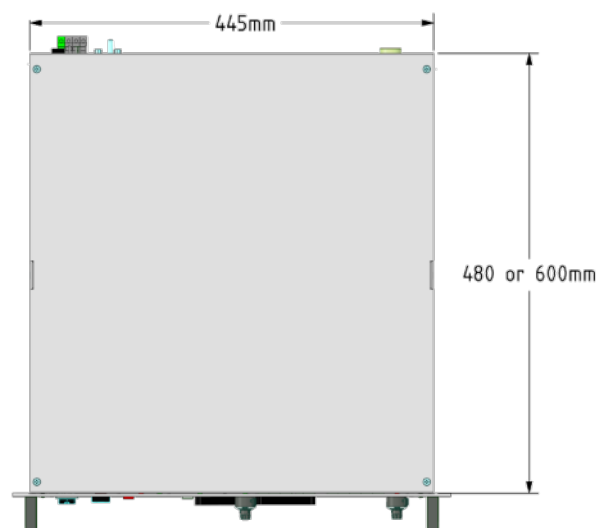
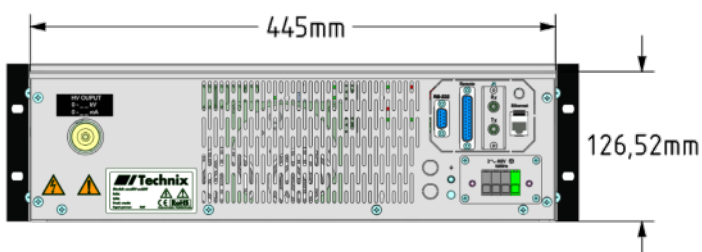
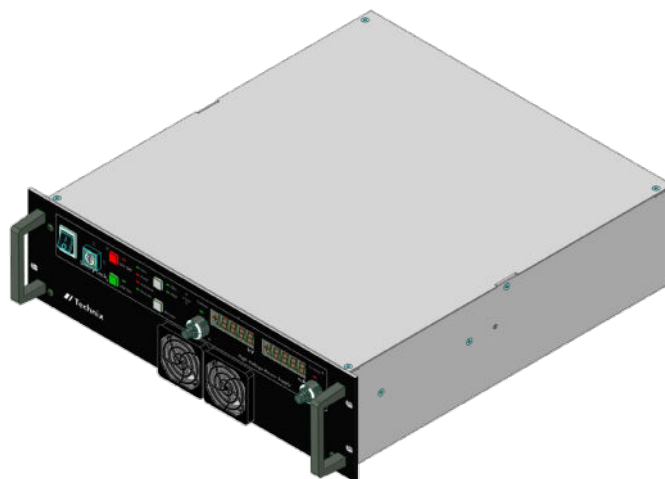

DIMENSION

MODEL 5U - 19" : 222 x 483 x 480 or 600 mm (H x W x D)

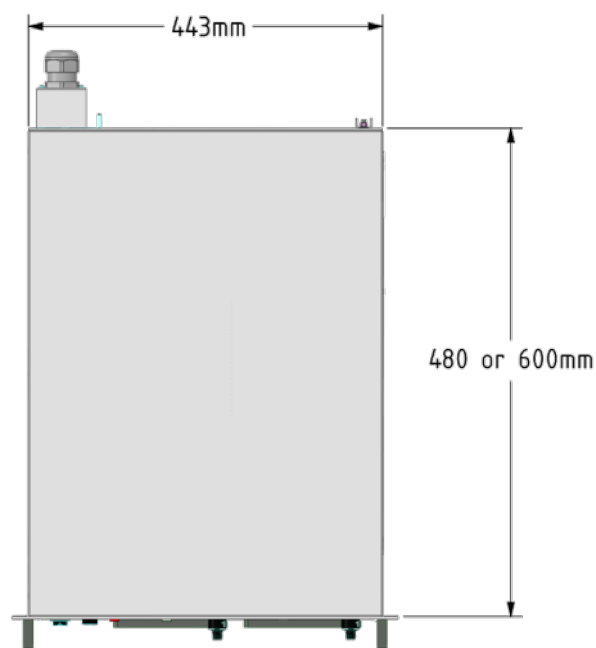
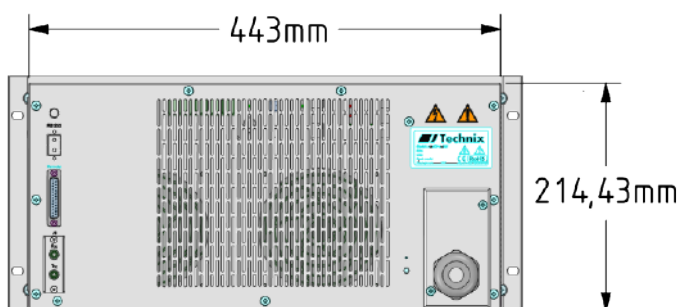
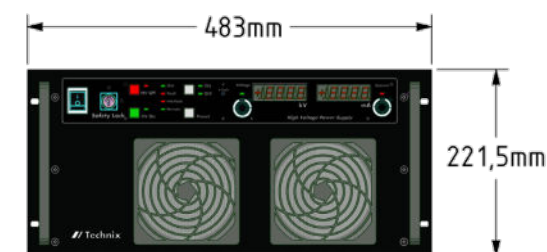
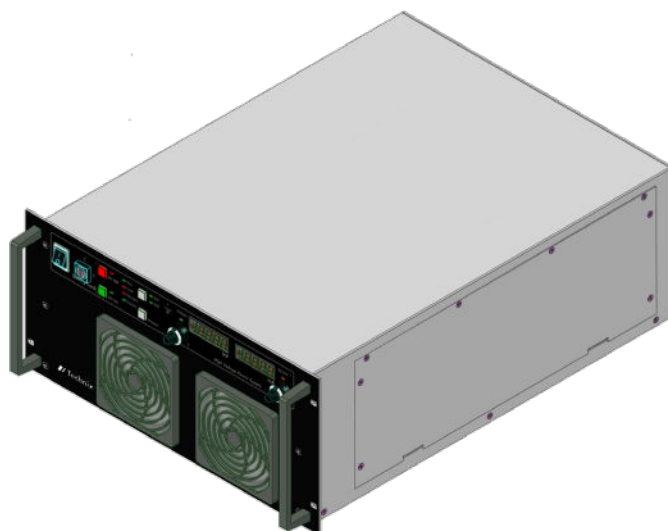

DIMENSION

MODEL 7U - 19" : 311 x 483 x 600 mm (H x W x D)

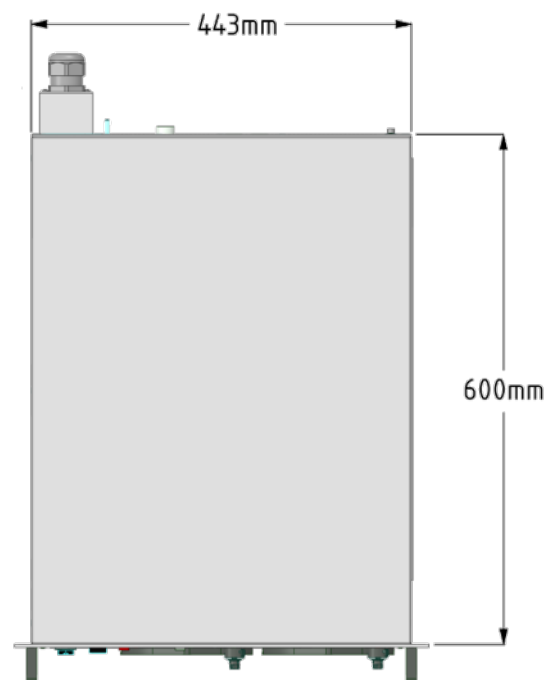
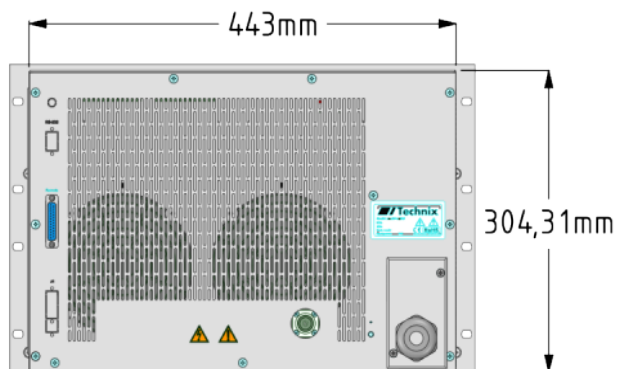
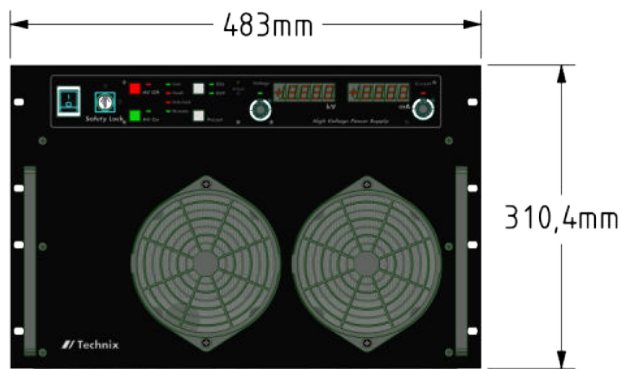
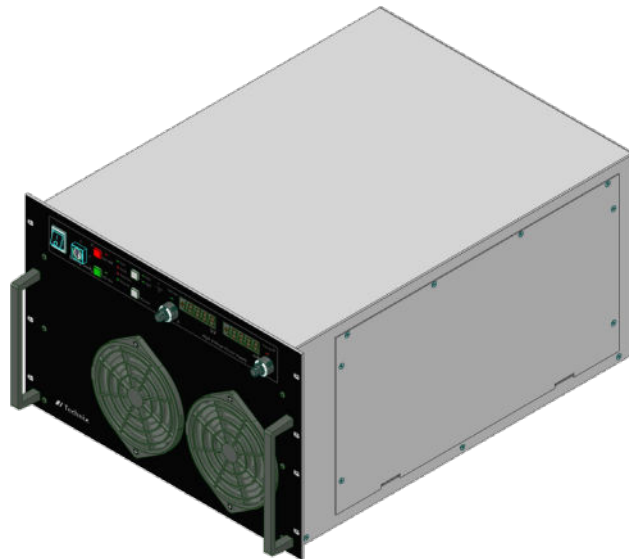

DIMENSION

MODEL 10U - 19" : 444 x 483 x 600mm (H x W x D)

